

REVISION RECORD				
SYM	DESCRIPTION	BY	DATE	APPD
A	RELEASED FOR MFG.	RA	8/24/18	RA

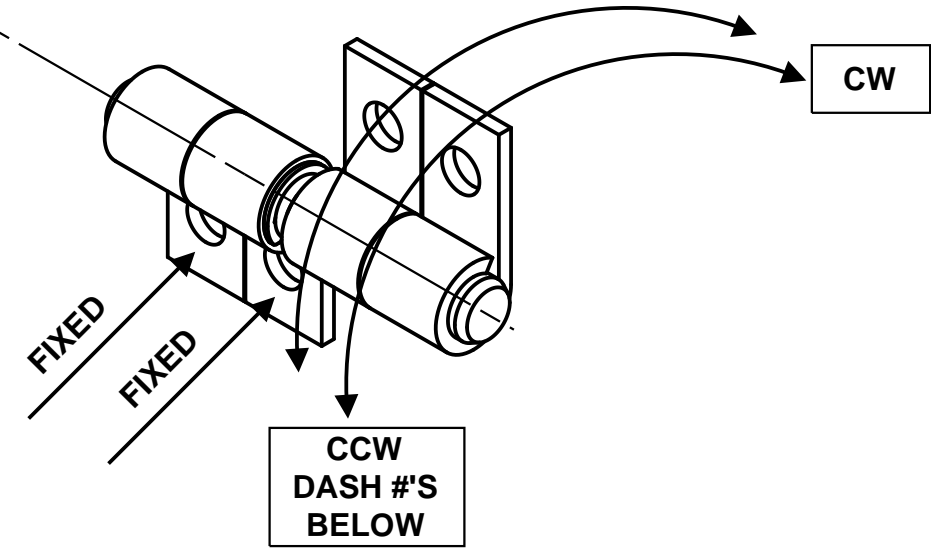

ROTATION AS SHOWN FOR TORQUE CALLOUT  
CW < CCW

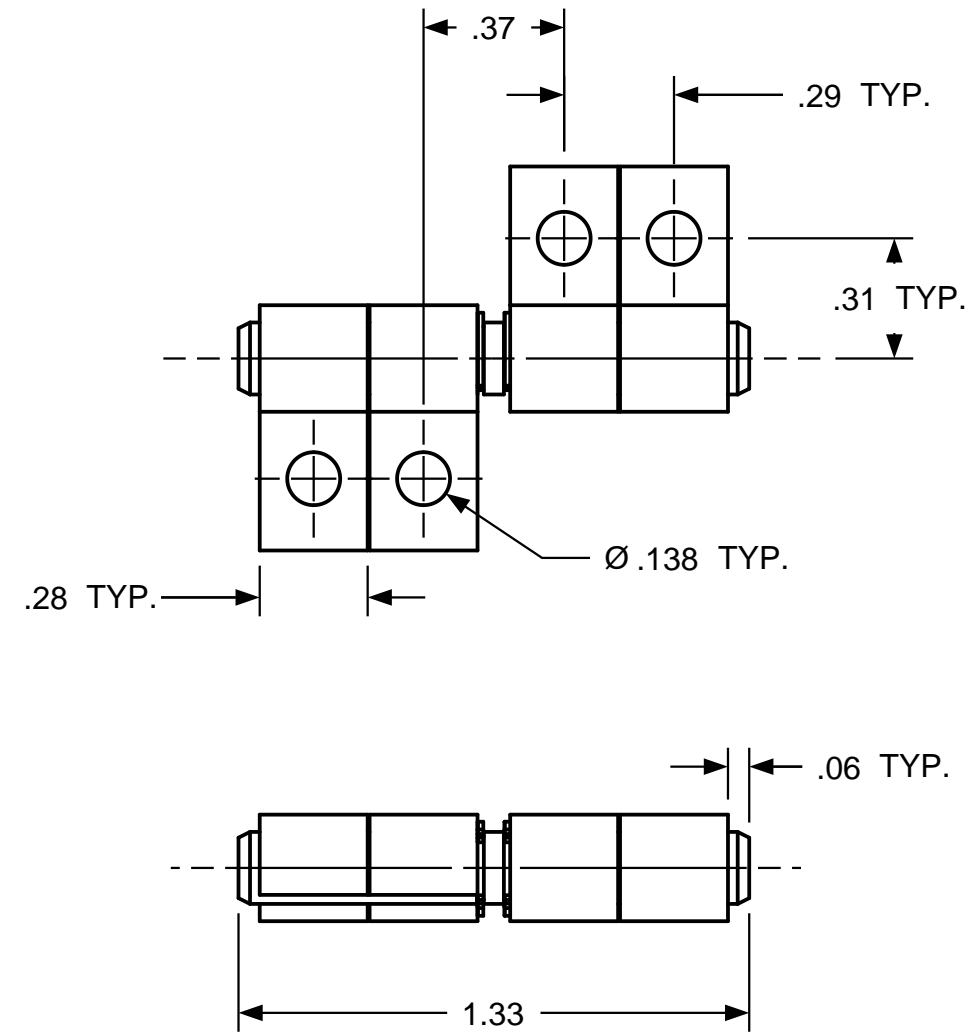

TORQUE - CCW	
-1-	1.5 - 3.0 IN LB
-2-	3.0 - 4.5 IN LB
-3-	4.5 - 6.0 IN LB
-4-	6.0 - 7.5 IN LB
-5-	7.5 - 9.0 IN LB
-6-	9.0 - 10.5 IN LB
-7-	10.5 - 12.0 IN LB

CUSTOM TORQUE CONFIGURATIONS AVAILABLE.

USED ON	SOLID	REV	TOLERANCES		ENGLISH / METRIC		Torq MASTER INTERNATIONAL		200 HARVARD AVE STAMFORD, CT USA	
STANDARD	264	A	ENGLISH	METRIC						
NEXT ASSY	N/A		.XX ±.015 IN	.X ±.4 MM	DRAWN BY	DATE	MATERIAL N/A			
QUANTITY			.XXX ±.005 IN	.XX ±.13 MM	RA	8/24/18	TITLE HINGE INTERFACE DRW			
PER ASSY, PCS			.XXXX ±.0002 IN	.XXX ±.05 MM	CHECKED BY	DATE	SIZE B		REV A	
TOTAL, PCS					RA	8/24/18	SB 188 SB 264			
THIS INFORMATION IS PROPRIETARY TOTORQMASTER, INTL. THE POSSESSOR AGREES TO MAINTAIN IT IN CONFIDENCE, NOT REPRODUCING OR REVEALING IT IN WHOLE OR IN PART.							SCALE NTS		SHEET 1 OF 1	